



ALARIS
KUHNE

INSPIRING THE NEXT RF SOLUTION

+49 (0) 9293 - 800 640
sales@kuhne.alaris.tech
www.kuhne.alaris.tech
Scheibenacker 3, 95180 Berg,
Germany

Version 1.0

KU LNC 2229 C PRO2



Manual

Directors: Ian Duke/Gustav Wenhold
Reg no: HRB 3350 Hof, VAT-ID-No: DE 813343044, WEEEReg.-Nr. DE34186665

Kuhne electronic GmbH
Scheibenacker 3, 95180 Berg
Germany

A DIVISION OF

ALARIS
THE RF TECHNOLOGY GROUP



Specifications (Ta = 25 °C):

Type

KU LNC 2229 C PRO2

Frequency range (RF)
 Noise figure @ 18 °C
 Gain (switchable)
 Output IP3

2200 ... 2900 MHz
 typ. 0.8 dB, max. 1.0 dB (LO frequency 2040 MHz, IF amplifier enabled)
 typ. 35 dB (high gain), typ. 24 dB (low gain) (LO frequency 2040 MHz)
 typ. +25 dBm (high gain), typ. +14 dBm (low gain)

Switchable LO, IF frequencies

Output frequency (LO 2040, 3060 MHz)
 Output frequency (LO 2000 MHz)
 Output frequency (LO 2100 MHz)
 LO accuracy @ 18 °C
 LO frequency stability (0 ... 40 °C)

160 ... 860 MHz
 200 ... 900 MHz
 100 ... 800 MHz
 +/- 2 ppm
 +/- 3 ppm

Phase noise @ 2040 MHz

@ 1 kHz
 @ 10 kHz
 @ 100 kHz

typ. -98 dBc/Hz
 typ. -110 dBc/Hz
 typ. -110 dBc/Hz

Operating parameters

Supply voltage
 Current consumption
 Power consumption

+9 ... 36 V DC
 typ. 250 mA @ 12V (IF amplifier enabled)
 typ. 3.0 W

Mechanics

Input connector / impedance
 Output connector / impedance
 Case
 Dimensions (mm)
 Weight

N-female, 50 ohms
 N-female, 50 ohms
 milled aluminium, IP67
 82 x 64 x 22
 typ. 230 g

Absolute ratings

Maximum RF input power
 Operating case temperature range

1 mW (0 dBm)
 -20 ... +55 °C

Features

- Low noise figure
- Large bandwidth
- Low phase noise oscillator
- High frequency stability of the oscillator
- High linearity
- Antenna port protected against static discharge
- Small and light-weight to allow easy pole mounting
- Tri-colour LED indicates unit status and gain mode setting
- Overvoltage protection and reverse polarity protection
- Remote power supply via output connector

Applications

- Multichannel Multipoint Distribution Services (MMDS)
- Digital broadcast systems (DVB-T, DVB-S)
- Analog and digital transmission systems

CE Konformität / CE Conformity

EMC directive 2014/30/EU
 Low voltage directive 2014/35/EU
 RoHS directive 2011/65/EU





Dimensions / Mounting holes

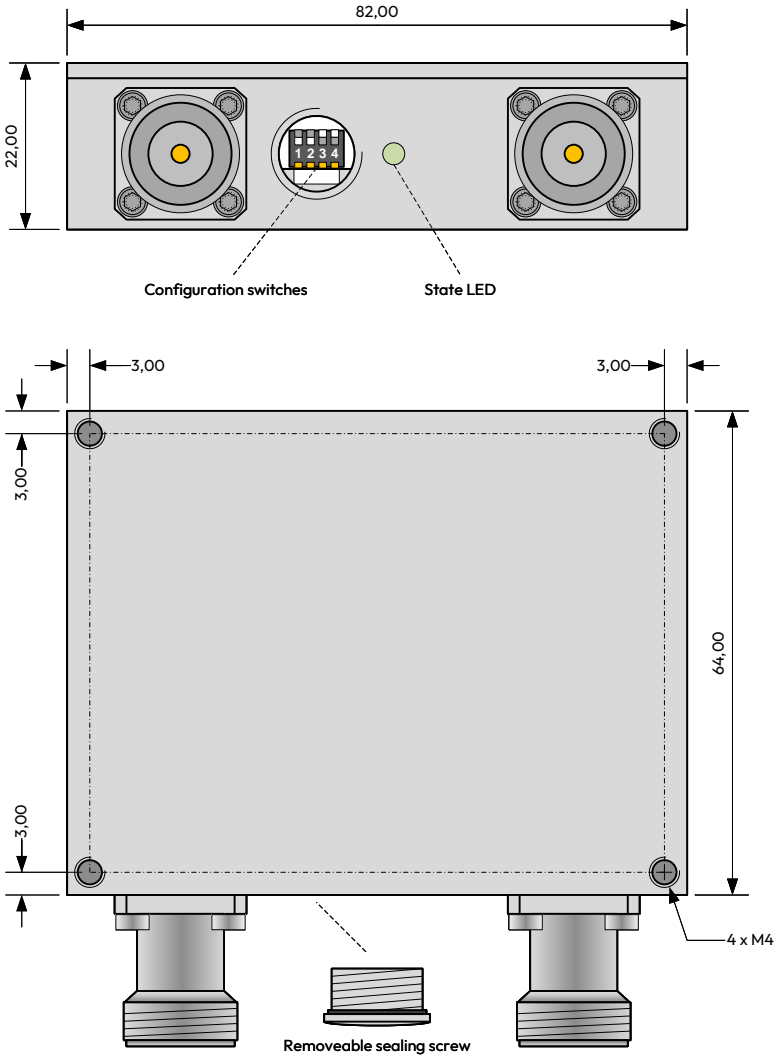

Configuration Switches / LED state

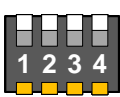

OFF
ON

Switch 1 + 2 - (Local oscillator frequency)
Switch 3 - (Gain)
Switch 4 - (User local oscillator frequency)

Device Error

LED state
Red

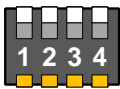

OFF
ON

Switch 1 - OFF
Switch 2 - OFF
 LO 2040 MHz
 IF 160 ... 860 MHz

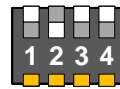

OFF
ON

Switch 1 - OFF
Switch 2 - ON
 LO 2100 MHz
 IF 100 ... 800 MHz

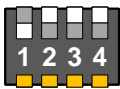

OFF
ON

Switch 1 - ON
Switch 2 - OFF
 LO 2000 MHz
 IF 200 ... 900 MHz

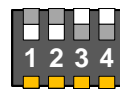

OFF
ON

Switch 1 - ON
Switch 2 - ON
 LO 3060 MHz
 IF 160 ... 860 MHz (reverse)

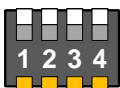

OFF
ON

Switch 3 - OFF
 Low Gain

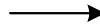

LED state
Green

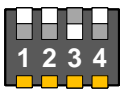

OFF
ON

Switch 3 - ON
 High Gain

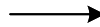

LED state
Blue

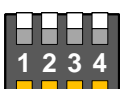

OFF
ON

Switch 4 - OFF
 Local oscillator configuration with Switch 1 + 2

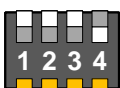

OFF
ON

Switch 4 - ON
 Local oscillator configuration with Switch 1 + 2 disabled
 User defined local oscillator frequency is enabled

In the case that **Switch 4** is in position **ON** the user defined local oscillator frequency is activated.
 This user defined local oscillator frequency can be selected in the range from 2000 ... 2100 MHz and from 3000 ... 3100 MHz.
 The frequency step size of the oscillator frequency is 10 MHz.
 The user defined oscillator frequency can be programmed with a special programming cable (see next page).

For example the oscillator frequency can be chosen to 2070 MHz or 3020 MHz .

Optional Connector PCB

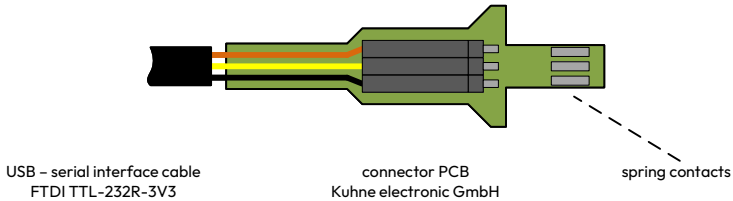

Configure the user defined local oscillator frequency

- connect the USB – serial interface cable with your PC
- start a terminal program on your PC (for example „hterm“)
- choose the COM port of the USB – serial interface cable

```
BAUDRATE 9600
DATABITS 8
STOPBITS 1
NO FLOW CONTROL
```

- insert the connector PCB with connected USB – serial interface cable into the configuration slot the spring contact must show to the top cover of the down converter
- power up the down converter
- send „s“ with the terminal program to the converter to get the state of the converter

```
Kuhne electronic GmbH - KU LNC 2229 C PRO2

PLL locked
GAIN high
Selected LO frequency: 2040 MHz
User defined LO frequency: 2040 MHz
User defined LO frequency enabled
```

- send „2060LO“ with the terminal program to the converter to get set the user defined oscillator frequency to 2060 MHz
- power down the down converter
- remove the connector PCB

Mounting instructions

All LNCs from Kuhne electronic GmbH are labelled with at least protection class IP41 in accordance with DIN EN 60529, **unless a higher protection class is explicitly indicated in the valid specifications for the protection class on page 2.**

This provides information on the resistance of the unit against unwanted penetration of foreign bodies or moisture into the interior of the unit according to the following provision:

- Protected against granular solid foreign bodies (diameter ≥ 1 mm).
- Protection against falling spray up to 60° from vertical

The LNC modules have been designed with maximum protection against moisture. Nevertheless, water may enter the unit due to the design of the RF connectors, which is why some special features should be taken into account during installation.

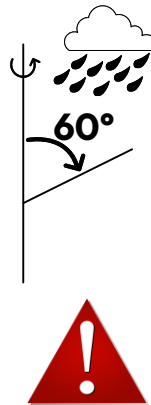
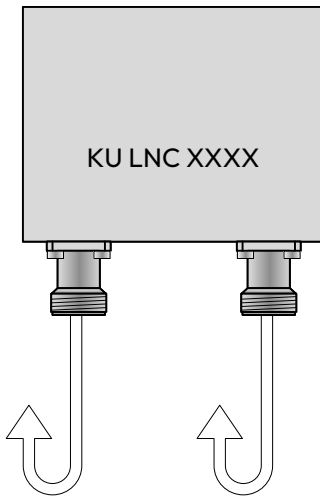

Mounting with the RF connectors vertically downwards

If possible, do not use cable connections with angled elbow connectors, but lead plugs out with a straight cable and a loop pointing downwards.

In the event of improper installation or handling that does not comply with our recommendations, Kuhne electronic reserves the right to exclude the warranty claim.



Application diagram

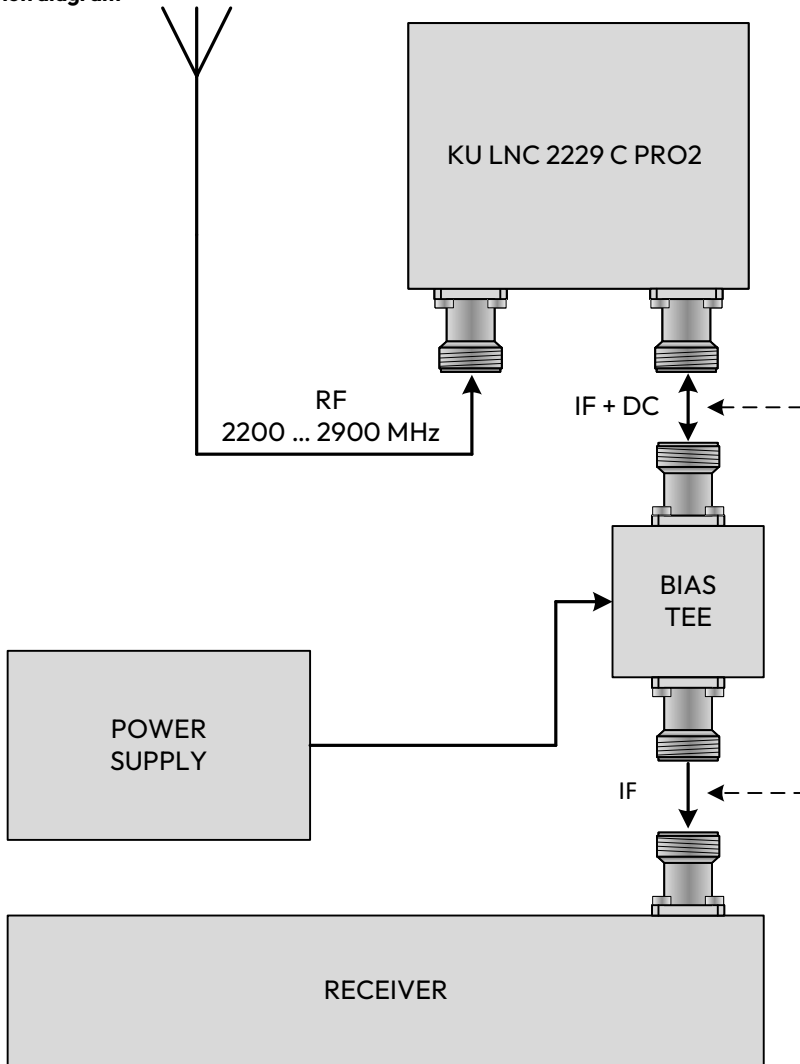



Typical performance

Typical phase noise (2040 MHz local oscillator frequency)

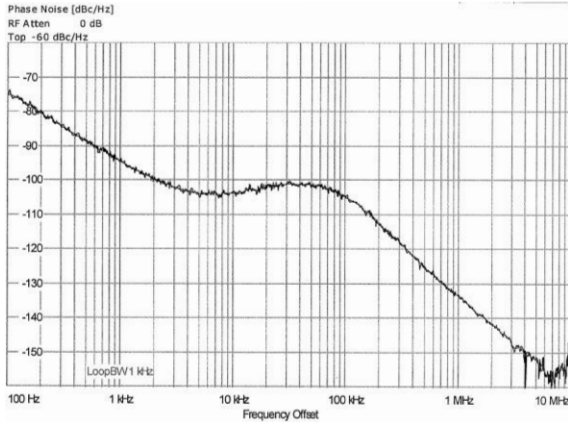

Typical gain and noise figure (2040 MHz local oscillator frequency)

